

## HINNASTO 2010

TUOTE	KOKO	RUUVIN KOKO	HINTA €
Putkisanka SFS 5370 HST	DN 10/17	M 6 x 20	4,94
	15/21	M 8 x 25	6,43
	20/27		7,42
	25/34		8,65
	32/42	M 10 x 30	10,18
	40/48		10,72
	50/60	M 10 x 40	11,71
	65/76	M 12 x 35	13,39
	80/89		13,99
	100/114	M 16 x 50	25,54
	125/140		28,22
	150/168		30,14
	200/219		42,84
	250/273	M 20 x 60	67,96
	300/324		75,77
	350/355		81,12
400/406	M 24 x 70	131,78	
500/508		158,15	



Putkisanka SFS 5370 sinkitty	DN 10/17	M 6 x 20	1,24
	15/21	M 8 x 25	1,24
	20/27		1,31
	25/34		1,37
	32/42	M 10 x 30	1,52
	40/48		1,69
	50/60	M 10 x 40	2,04
	65/76	M 12 x 35	2,58
	80/89		2,93
	100/114	M 16 x 50	6,18
	125/140		6,91
	150/168		8,18
	200/219		11,52
	250/273	M 20 x 60	17,51
	300/324		18,11
	350/355		22,16
400/406	M 24 x 70	35,84	
500/508		40,93	



## HINNASTO 2010

Putkisanka  
SFS 5370 musta

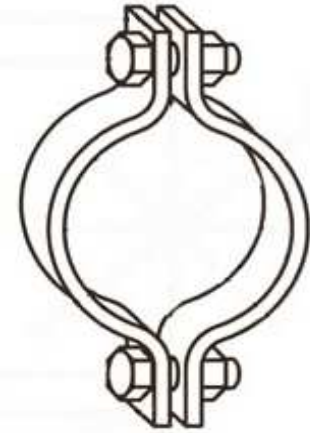

DN 10/17	M 6 x 20	1,15
15/21	M 8 x 25	1,15
20/27		1,22
25/34		1,28
32/42	M 10 x 30	1,42
40/48		1,58
50/60	M 10 x 40	1,91
65/76	M 12 x 35	2,41
80/89		2,74
100/114	M 16 x 50	5,78
125/140		6,46
150/168		7,65
200/219		10,76
250/273	M 20 x 60	16,36
300/324		16,92
350/355		20,72
400/406	M 24 x 70	33,50
500/508		38,25

Putkisanka  
SFS 5371 sinkitty

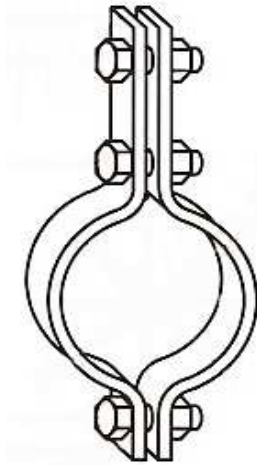

DN 10/17	M 6 x 20	1,60
15/21		1,60
20/27	M 10 x 30	1,87
25/34		1,92
32/42		1,92
40/48		2,10
50/60	M 12 x 35	2,58
65/76		3,20
80/89		3,77
100/114	M 16 x 50	7,68
125/140		8,65
150/168		10,52
200/219		14,29
250/273	M 20 x 60	22,00
300/324		22,32
350/355		27,68
400/406	M 24 x 70	45,54
500/508		52,26

## HINNASTO 2010

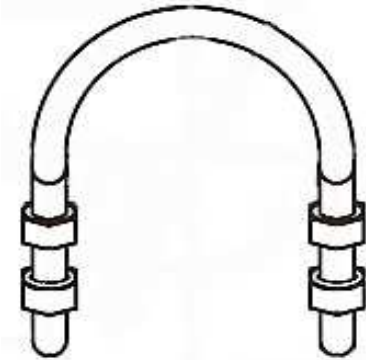
TUOTE	KOKO	RUUVIN KOKO	HINTA
U-sanka SFS 5369 	10/17	M 8	1,40
	15/2		1,62
	20/27		1,56
	25/34	M 10	1,73
	32/42		1,79
	40/48		1,94
	50/60	M 12	2,08
	65/76		2,22
	80/89		2,46
	100/114	M 16	3,64
	125/140		3,85
	150/168		4,70
	200/219	M 20	8,15
	250/273		10,38
	300/324		24,86
	350/356	M 24	26,70
	406/428		28,18
508/530	34,10		

Kevyt kynsiohjain  
SFS 5366

fe musta  
Hst kevyt

0,60  
1,44

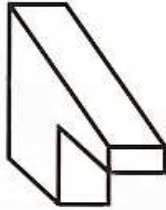

Raskas kynsiohjain  
SFS 5367

2,70

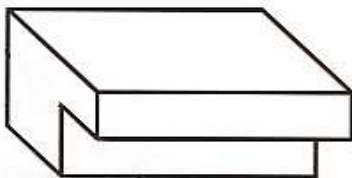

## HINNASTO 2010

TUOTE	KOKO	RUUVIN KOKO	HINTA
Irtojousi SFS 5393/1 	n:o 1		22,86
	2		33,26
	3		55,12
	4		89,75
	5		169,78
	6		341,30

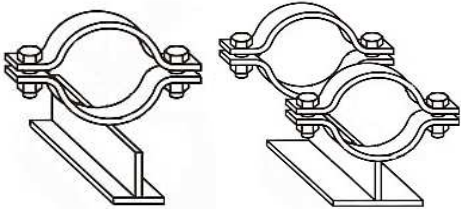
Liukukannatin SFS 5373 sinkitty, pultattuna 	DN 10		6,07
	15		6,23
	20	8 x 25	6,43
	25		6,77
	32	10 x 30	7,45
	40		9,07
	50		14,54
	65		15,44
	80		16,92
	100	16 x 50	22,30
125		23,76	
150		27,02	

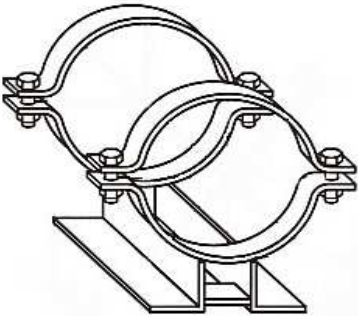
Liukukannatin SFS 5374 sinkitty, pultattuna 	DN 200	16 x 50	42,97
	250	20 x 60	54,41
	300		66,53
	350		71,37
	400	24 x 80	98,41
	500		101,18

## HINNASTO 2010

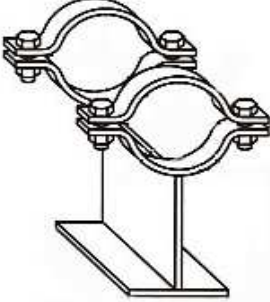
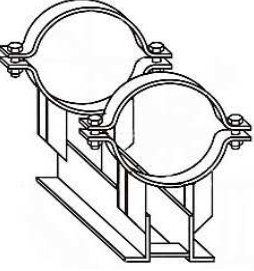
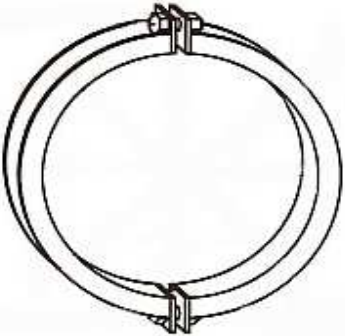
TUOTE	KOKO	RUUVIN KOKO	HINTA
Liukukannatin SFS 5376 sinkitty, pultattuna 	DN 10		11,09
	15		11,84
	20	8 x 25	12,15
	25		16,99
	32	10 x 30	17,86
	40		18,22
	50	10 x 40	18,77
	65	12 x 35	19,24
	80		23,24
	100	16x 50	35,33
	125		37,42
150		38,81	
Liukukannatin SFS 5377 sinkitty, pultattuna 	DN 200		64,44
	250		79,00
	300		91,48
	350		98,77
	400		116,42
	500		135,83
Putkisanka SFS 5372 sinkitty, pultattuna 	DN 600/610	M30 x 80	102,92
	700/712		120,24
	800/813		133,06
	900/915		150,37
	1000/1016		163,21
	1200/1220		193,34

## HINNASTO 2010

TUOTE	KOKO	RUUVIN KOKO	HINTA
Liukukannatin SFS 5375 sinkitty, pultattuna	DN 600	M 30 x 80	241,15
	700		301,45
	800		325,37
	900		377,68
	1000		401,92
	1200		481,61

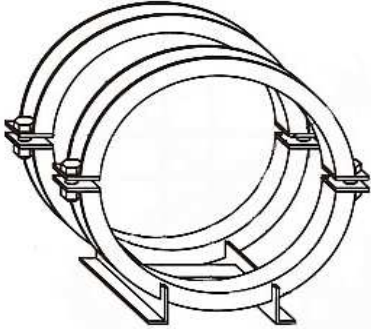

Liukukannatin SFS 5378 sinkitty, pultattuna	DN 600	M30 x 80	305,26
	700		350,64
	800		385,65
	900		436,57
	1000		466,04
	1200		533,59

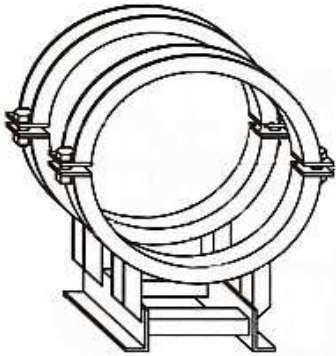



Kierretanko sinkitty pätkitty SFS 5381 sinkitty 2 mutteria	PUTKEN KOKO		
	10 x 300		1,39
	12 x 300		1,91
	16 x 300		3,20
	20 x 300		4,79
24 x 300		5,83	

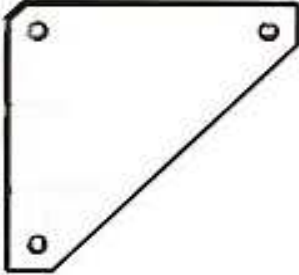
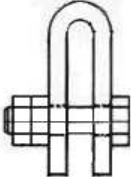
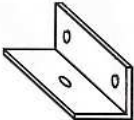

## HINNASTO 2010

TUOTE	KOKO	PUTKEN KOKO	HINTA
Silmukkalevy SFS 5382 musta 	n:o 1		1,15
	2		1,51
	3		1,91
	4		2,97
	5		4,00
	Kolmiolevy musta SFS 5384 	n:o 2	DN 50
		65	11,57
		80	11,57
3		100	26,33
		125	26,33
		150	26,33
		200	26,33
4		250	40,55
		300	40,55
		350	40,55
		400	55,80
	500	55,80	
Korvake SFS 5383 Znk 	n:o 1		1,91
	2		2,66
	3		7,20
	4		18,70
	5		37,78
Kiinnike A SFS 5385 Znk 	n:o 1		5,81
	2		7,60
	3		13,16
	4		24,71
	5		39,17

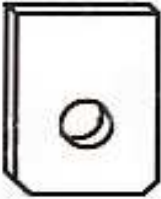
# HINNASTO 2010

TUOTE	KOKO	RUUVIN KOKO	HINTA
Kiinnike B SFS 5386 Znk	n:o 1		8,78
	2		11,16
	3		20,66
	4		39,17
	5		47,12
Kiinnike C SFS 5387 Znk	n:o 1		1,15
	2		1,39
	3		2,02
	4		3,26
	5		4,63
Kierresilmukkalevy SFS 5389 Znk	n:o 1		2,57
	2		3,13
	3		3,92
	4		5,83
	5		7,60
Kierrekorvake SFS 5390 Znk	n:o 1		4,79
	2		5,83
	3		8,78
	4		11,57
	5		15,14

# HINNASTO 2010

TUOTE	KOKO	RUUVIN KOKO	HINTA
Vanttiruuvi SFS 5391 ZnK	n:o 1		11,97
	2		14,78
	3		19,13
	4		23,36
	5		34,49

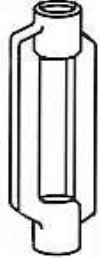

## PINTA

SFS 5393 Toimitettavat mallit * malli A	n:o 1	maalattuna 1 krs	51,12
	2		77,27
	3		111,24
	4		161,46
	5		279,95
	6		543,98

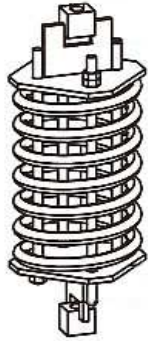

*malli B	n:o 1	maalattuna 2 krs	55,31
	2		82,06
	3		115,49
	4		171,63
	5		292,43
	6		558,54

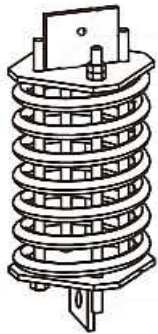

## HINNASTO 2010

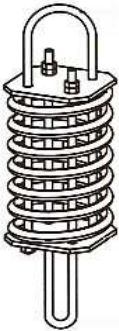
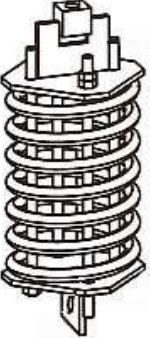
TUOTE	KOKO	PINTA	HINTA
* malli C		maalattuna	
	n:o 1	3 krs	57,55
	2		86,06
	3		121,03
	4		180,31
	5		301,25
	6		571,01
	* malli D		esikuormitus- lisä
	n:o 1		7,20
	2		9,70
	3		10,76
	4		14,69
	5		16,87
	6		30,49

## HINNASTO 2010

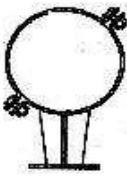
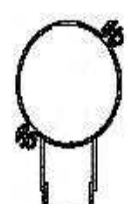
<b>L300-NOS2041 FeZnK. Sis. pultit ja mutterit. Hinta €/kpl.</b>						
	<b>DN</b>	<b>halk.</b>	<b>H=100</b>	<b>H=140</b>	<b>H=180</b>	<b>H=240</b>
	<b>DN15</b>	1/2"	17,02	20,34	22,82	27,80
	<b>DN20</b>	3/4"	17,02	20,34	22,82	27,80
	<b>DN25</b>	1"	17,40	20,72	23,64	28,63
	<b>DN32</b>	1 1/4"	17,84	21,16	24,07	29,04
	<b>DN40</b>	1 1/2"	17,84	21,16	24,07	29,10
	<b>DN50</b>	2"	18,66	22,01	24,89	29,86
	<b>DN65</b>	2 1/2"	19,91	23,21	26,17	30,89
	<b>DN80</b>	3"	20,34	23,64	26,56	31,51
	<b>DN100</b>	4"	28,21	31,51	34,00	39,00
	<b>DN125</b>	5"	29,86	33,18	35,68	40,67
	<b>DN150</b>	6"	31,13	34,46	37,34	41,68
	<b>DN200</b>	8"	49,38	53,90	58,07	64,31
	<b>DN250</b>	10"	53,09	58,07	62,23	70,52
	<b>DN300</b>	12"	57,25	62,23	66,37	74,26
	<b>DN350</b>	14"	92,53	101,65	112,01	124,44
	<b>DN400</b>	16"	116,17	124,44	134,40	149,40
	<b>DN500</b>	20"	124,86	136,90	147,72	161,76
	<b>DN600</b>	24"	224,03	232,31	240,60	255,12
	<b>DN700</b>	28"	244,76	253,07	261,36	273,84
	<b>DN800</b>	32"	265,49	273,79	282,12	298,68
	<b>DN900</b>	36"	315,28	325,66	336,00	352,68
	<b>DN1000</b>	40"	340,16	348,47	356,76	373,32

## HINNASTO 2010

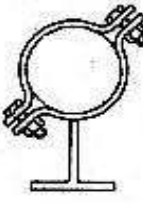
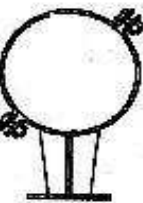
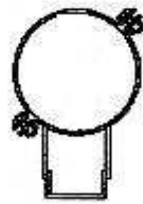
L400-NOS2041 FeZnK. Sis. pultit ja mutterit. Hinta €/kpl.						
	DN	halk.	H=100	H=140	H=180	H=240
	<b>DN15</b>	1/2"	22,01	26,55	29,86	36,52
	<b>DN20</b>	3/4"	22,01	26,55	29,86	36,52
	<b>DN25</b>	1"	22,39	26,98	30,31	36,92
	<b>DN32</b>	1 1/4"	22,82	27,38	30,69	37,35
	<b>DN40</b>	1 1/2"	23,22	27,79	31,12	37,73
	<b>DN50</b>	2"	23,63	28,21	31,52	38,16
	<b>DN65</b>	2 1/2"	24,88	29,05	33,19	39,40
	<b>DN80</b>	3"	25,31	29,45	33,61	39,83
	<b>DN100</b>	4"	33,19	37,35	41,49	45,65
	<b>DN125</b>	5"	34,47	38,59	42,73	48,98
	<b>DN150</b>	6"	35,68	39,83	43,97	50,62
	<b>DN200</b>	8"	51,84	58,07	63,49	72,59
	<b>DN250</b>	10"	57,26	63,49	68,85	78,01
	<b>DN300</b>	12"	62,23	68,47	73,85	83,00
	<b>DN350</b>	14"	109,10	121,55	136,89	152,98
	<b>DN400</b>	16"	132,73	145,21	151,85	178,38
	<b>DN500</b>	20"	145,21	157,63	165,94	190,80
	<b>DN600</b>	24"	248,90	261,32	273,80	294,52
	<b>DN700</b>	28"	269,64	282,10	294,52	315,27
	<b>DN800</b>	32"	319,45	344,32	356,78	377,51
	<b>DN900</b>	36"	365,04	377,51	389,97	402,39
	<b>DN1000</b>	40"	373,34	385,81	398,23	414,85

## HINNASTO 2010

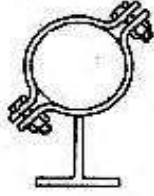
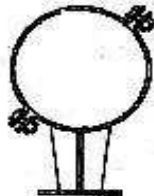
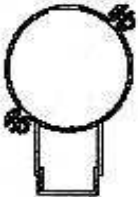
<b>L500-NOS2041 FeZnK. Sis. pultit ja mutterit. Hinta €/kpl.</b>							
	<b>DN</b>	<b>halk.</b>	<b>H=100</b>	<b>H=140</b>	<b>H=180</b>	<b>H=240</b>	
	<b>DN15</b>	1/2"	26,56	31,94	36,91	41,87	
	<b>DN20</b>	3/4"	26,56	31,94	36,92	41,87	
	<b>DN25</b>	1"	27,38	32,80	37,34	45,65	
	<b>DN32</b>	1 1/4"	27,79	33,18	37,73	46,03	
	<b>DN40</b>	1 1/2"	28,21	33,61	38,16	46,46	
	<b>DN50</b>	2"	28,64	34,00	38,59	46,88	
	<b>DN65</b>	2 1/2"	29,45	34,86	39,40	47,70	
	<b>DN80</b>	3"	29,87	35,24	39,83	48,13	
	<b>DN100</b>	4"	37,36	43,15	47,71	56,00	
	<b>DN125</b>	5"	38,99	44,83	49,38	57,68	
	<b>DN150</b>	6"	40,67	46,46	50,62	58,88	
		<b>DN200</b>	8"	56,83	64,31	70,53	82,99
		<b>DN250</b>	10"	62,23	70,52	75,49	86,32
<b>DN300</b>		12"	66,80	74,26	80,50	91,25	
	<b>DN350</b>	14"	125,76	141,06	157,62	182,54	
	<b>DN400</b>	16"	149,40	165,94	182,54	207,42	
	<b>DN500</b>	20"	161,76	178,38	194,96	219,89	
	<b>DN600</b>	24"	273,84	290,40	306,98	331,86	
	<b>DN700</b>	28"	290,76	311,14	327,74	352,62	
	<b>DN800</b>	32"	369,24	385,81	421,05	456,34	
	<b>DN900</b>	36"	390,00	427,30	462,56	494,50	
	<b>DN1000</b>	40"	410,64	443,87	473,73	506,10	

## HINNASTO 2010

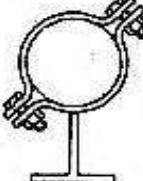
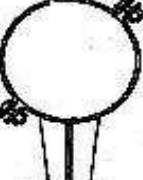
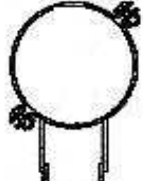
<b>L600-NOS2041 FeZnK. Sis. pultit ja mutterit. Hinta €/kpl.</b>						
	<b>DN</b>	<b>halk.</b>	<b>H=100</b>	<b>H=140</b>	<b>H=180</b>	<b>H=240</b>
	<b>DN15</b>	1/2"	31,52	38,16	43,97	55,19
	<b>DN20</b>	3/4"	31,51	38,16	43,97	55,19
	<b>DN25</b>	1"	31,94	38,59	44,36	55,58
	<b>DN32</b>	1 1/4"	32,37	39,00	44,83	56,00
	<b>DN40</b>	1 1/2"	32,80	39,41	45,22	56,40
	<b>DN50</b>	2"	33,18	39,83	45,65	56,82
	<b>DN65</b>	2 1/2"	34,00	40,67	46,46	57,68
	<b>DN80</b>	3"	34,47	41,05	46,88	58,07
	<b>DN100</b>	4"	42,30	49,38	54,72	64,69
	<b>DN125</b>	5"	43,97	50,62	56,40	66,37
	<b>DN150</b>	6"	45,22	52,26	57,68	67,66
		<b>DN200</b>	8"	61,82	63,18	77,54
<b>DN250</b>		10"	66,37	75,07	82,56	92,53
<b>DN300</b>		12"	71,77	80,08	87,11	99,55
	<b>DN350</b>	14"	142,71	160,97	181,73	211,56
	<b>DN400</b>	16"	165,94	183,36	207,42	232,31
	<b>DN500</b>	20"	178,38	199,13	219,89	248,90
	<b>DN600</b>	24"	297,86	315,28	336,02	365,04
	<b>DN700</b>	28"	319,44	336,02	356,78	385,81
	<b>DN800</b>	32"	402,39	452,17	481,21	522,71
	<b>DN900</b>	36"	423,15	472,92	501,94	543,44
	<b>DN1000</b>	40"	452,17	493,68	522,71	676,18

## TOIMITUSEHDOT

Hinnasto alkaen 1.1.2010

- \* Toimitusehto on vapaasti varastossamme.
- \* Alle 85 euron kertaostoista perimme 8,50 euron toimituslisän.
- \* Alle 85 euron kertaostoista emme myönnä alennusta.
- \* Lähetys vakuutetaan ainoastaan asiakkaan pyynnöstä.
- \* Tämän hinnaston hintoihin ei sisälly arvonlisäveroa.
- \* Yliaikakorkoa perimme 11 %.
- \* Palautuksista on sovittava myyjän kanssa. Meistä riippumattomista syistä aiheutuneista sovituista palautuksista hyvitämme 70 % laskutusarvosta.
- \* Yllämainittuja poikkeuksia lukuunottamatta sovellamme LVI-tukkukaupan yleisiä myyntiehtoja.
- \* Pidätämme oikeuden hintojen, mallien ja rakennemittojen muutokseen ilman edelläkäyvää ilmoitusta.
- \* Tuotteisiimme sisältyy tuotevastuuvakuutus.
- \* Maksuehto 14 pv netto.